

# LIFTING INSTRUCTIONS

AT-07

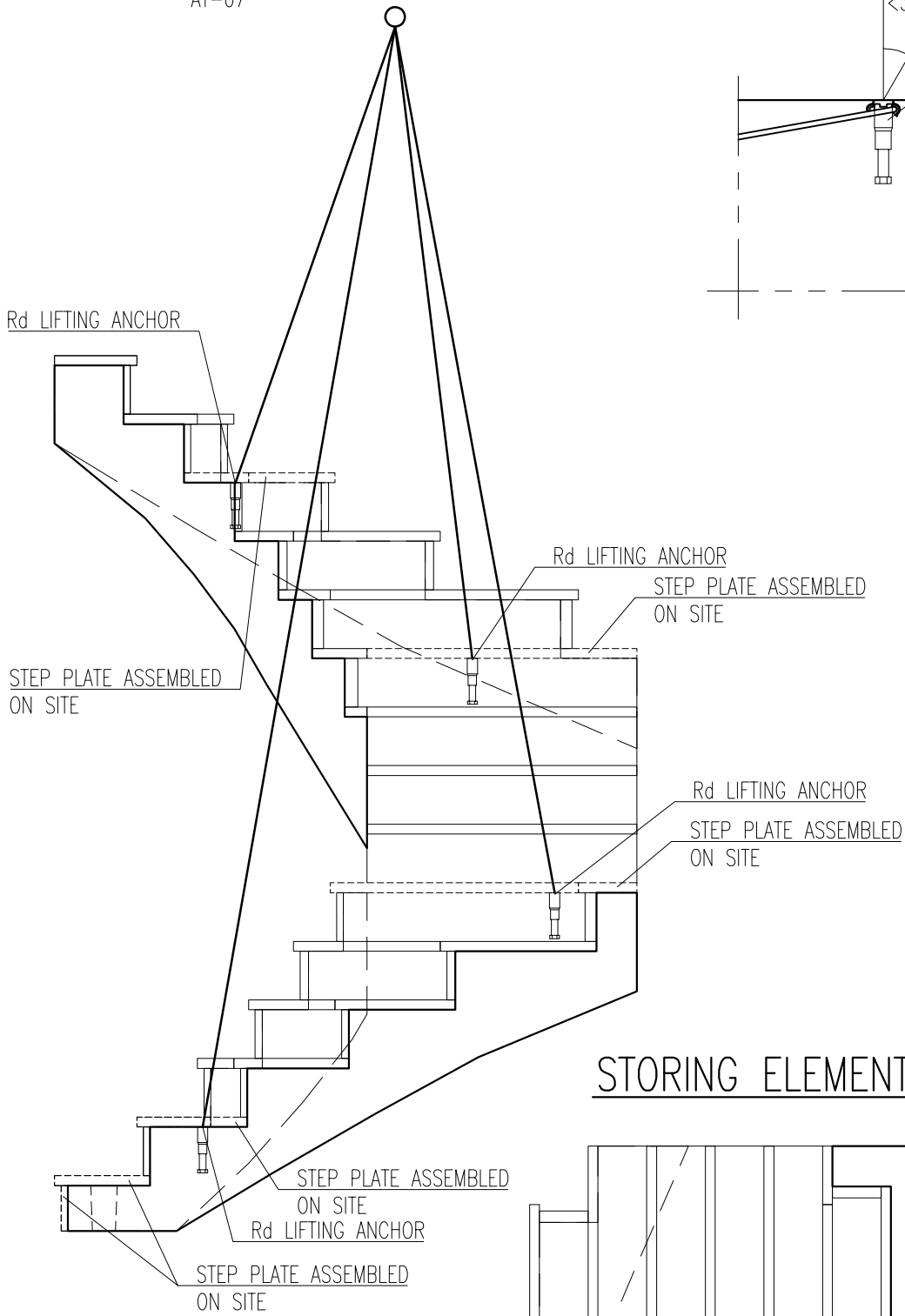

## STORING ELEMENTS

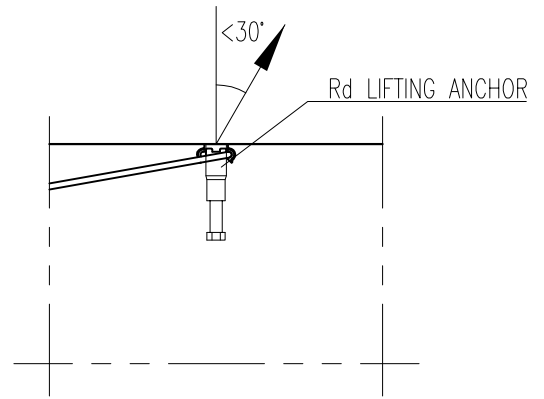