

DET-10

M1:10

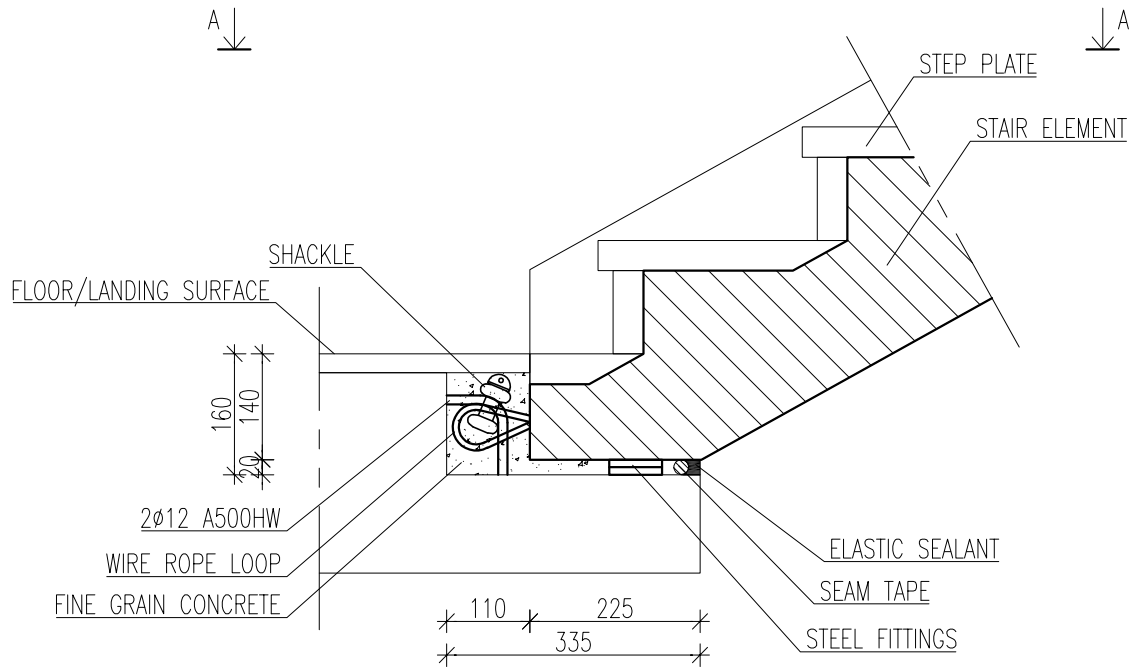

A-A

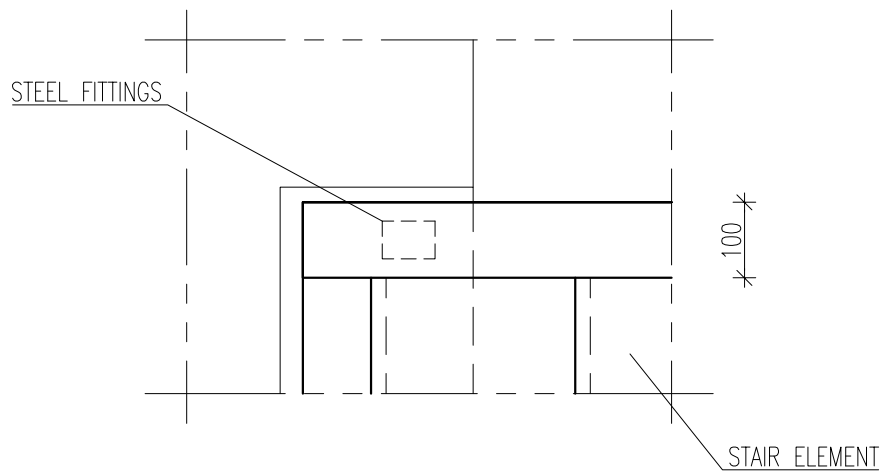

NOTES:

1. SHACKLE - DIN82101, d=20mm, 1.6t.